

BRFL20N70

Rev.A Feb.-2024

描述 / Descriptions

TO-220FL 塑封封装 N 沟道 MOS 场效应管。N-CHANNEL MOSFET in a TO-220FL Plastic Package.

特征 / Features

低栅电荷,低反馈电容,开关速度快,无卤产品。

Low gate charge, Low Crss , Fast switching, HF Product.

用途 / Applications

用于高频开关电源,电子镇流器,UPS 电源。

High efficiency switch mode power supplies, Electronic lamp ballasts based on half bridge, UPS.

内部等效电路 / Equivalent Circuit

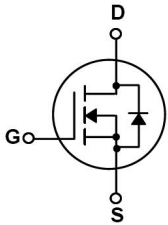

引脚排列 / Pinning

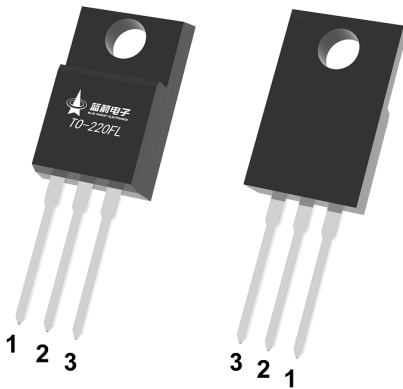

PIN1 : G

PIN 2 : D

PIN 3 : S

印章代码 / Marking

见印章说明。

See Marking Instructions.

极限参数 / Absolute Maximum Ratings(Ta=25°C)

参数 Parameter	符号 Symbol	数值 Rating	单位 Unit
Drain-Source Voltage	V_{DSS}	700	V
Drain Current	$I_D(T_C=25^\circ\text{C})$	20	A
Drain Current - Pulsed	I_{DM}	40	A
Gate-Source Voltage	V_{GSS}	± 30	V
Single Pulsed Avalanche Energy	E_{AS}	360	mJ
Avalanche Current	I_{AS}	8.5	A
Thermal Resistance, Junction to Case	$R_{\theta JC}$	3.125	$^\circ\text{C}/\text{W}$
Thermal Resistance, Junction to Ambient	$R_{\theta JA}$	62.5	$^\circ\text{C}/\text{W}$
Power Dissipation	P_D	40	W
Operating and Storage Temperature Range	T_J, T_{STG}	-55 to 150	$^\circ\text{C}$

电性能参数 / Electrical Characteristics(Ta=25°C)

参数 Parameter	符号 Symbol	测试条件 Test Conditions	最小值 Min	典型值 Typ	最大值 Max	单位 Unit
Drain-Source Breakdown Voltage	BV_{DSS}	$V_{GS}=0V$ $I_D=250\mu\text{A}$	700			V
Zero Gate Voltage Drain Current	I_{DSS}	$V_{DS}=700V$ $V_{GS}=0V$			1.0	μA
Gate-Body Leakage Current Forward	I_{GSS}	$V_{GS}=\pm 30V$ $V_{DS}=0V$			± 100	nA
Gate Threshold Voltage	$V_{GS(th)}$	$V_{DS}=V_{GS}$ $I_D=250\mu\text{A}$	2.0	3.2	4.0	V
Static Drain-Source On-Resistance	$R_{DS(on)}$	$V_{GS}=10V$ $I_D=10A$		0.45	0.55	Ω
Drain-Source Diode Forward Voltage	V_{SD}	$V_{GS}=0V$ $I_S=20A$			1.4	V
Input Capacitance	C_{iss}	$V_{DS}=25V$ $V_{GS}=0V$ $f=1.0\text{MHz}$		3280		pF
Output Capacitance	C_{oss}			128		pF
Reverse Transfer Capacitance	C_{rss}			3		pF
Total Gate Charge	Q_G	$V_{DD}=100V$ $I_D=20A$ $V_{GS}=10V$		54		nC
Gate-Source Charge	Q_{GS}			11		nC
Gate-Drain Charge	Q_{GD}			12		nC

电性能参数 / Electrical Characteristics(Ta=25°C)

参数 Parameter	符号 Symbol	测试条件 Test Conditions	最小值 Min	典型值 Typ	最大值 Max	单位 Unit
Turn-On Delay Time	$t_{d(on)}$	$V_{DD}=100V$ $I_D=20A$ $V_{GS}=10V$ $R_G=25\Omega$		28		ns
Turn-On Rise Time	t_r			35		
Turn-Off Delay Time	$t_{d(off)}$			135		
Turn-Off Fall Time	t_f			73		
Maximum Continuous Drain-Source Diode Forward Current	I_S				20	A
Maximum Pulsed Drain-Source Diode Forward Current	I_{SM}				40	A
Reverse Recovery Time	t_{rr}	$V_{GS} = 0V$ $I_S = 20A$		482		ns
Reverse Recovery Charge	Q_{rr}	$dI_F/dt = 100 A/\mu s$		8.5		μC

电参数曲线图 / Electrical Characteristic Curve

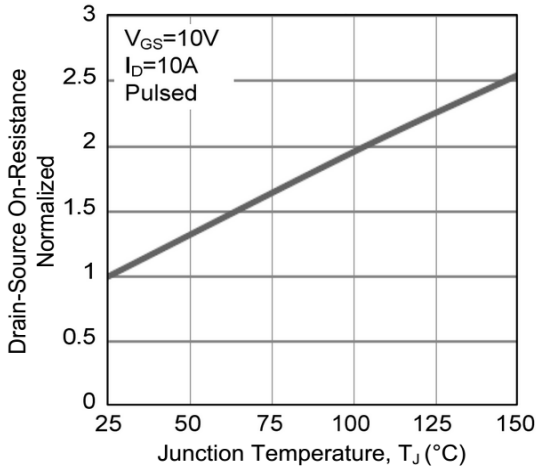

1. Drain-Source On-Resistance vs. Junction Temperature

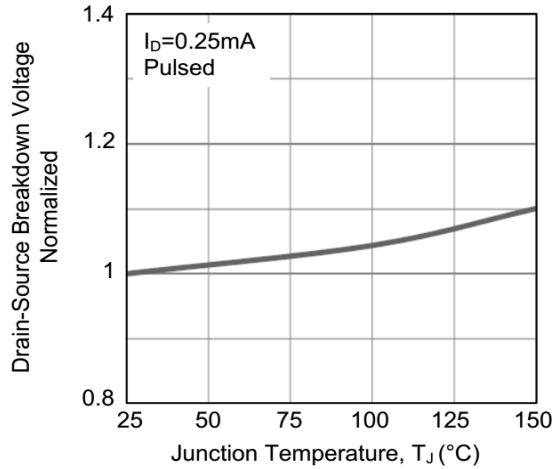

2. Breakdown Voltage vs. Junction Temperature

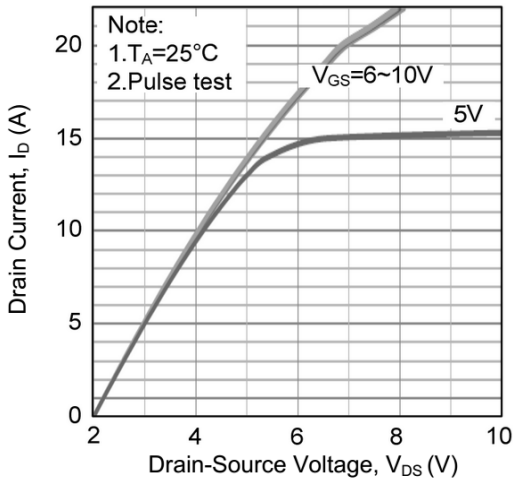

3. Drain Current vs. Drain-Source Voltage

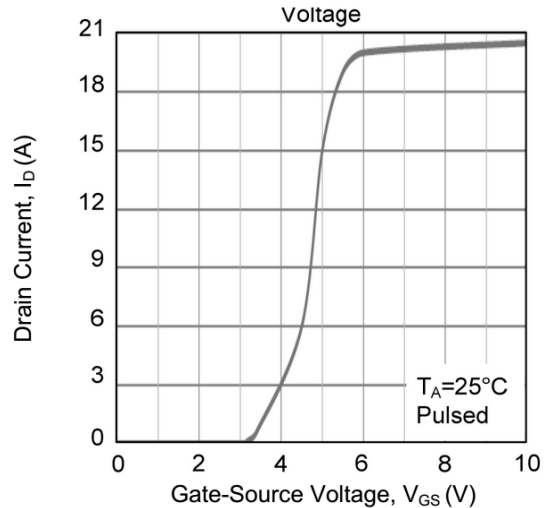

4. Drain Current vs. Gate-Source Voltage

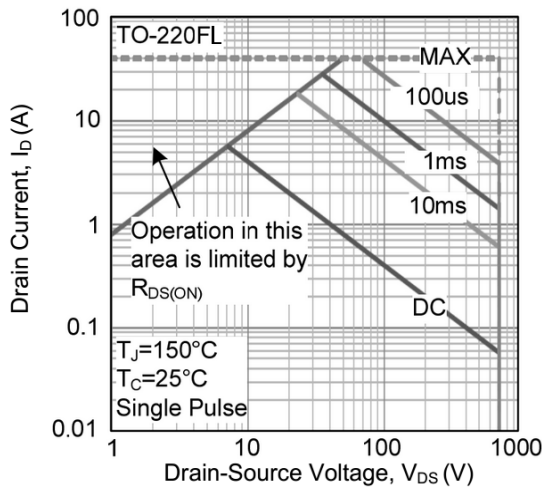

5. Safe Operating Area

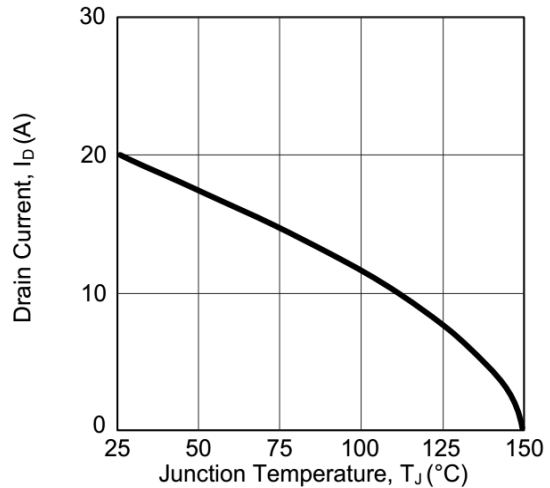

6. Drain Current vs. Junction Temperature

外形尺寸图 / Package Dimensions

TO-220FL

单位: mm

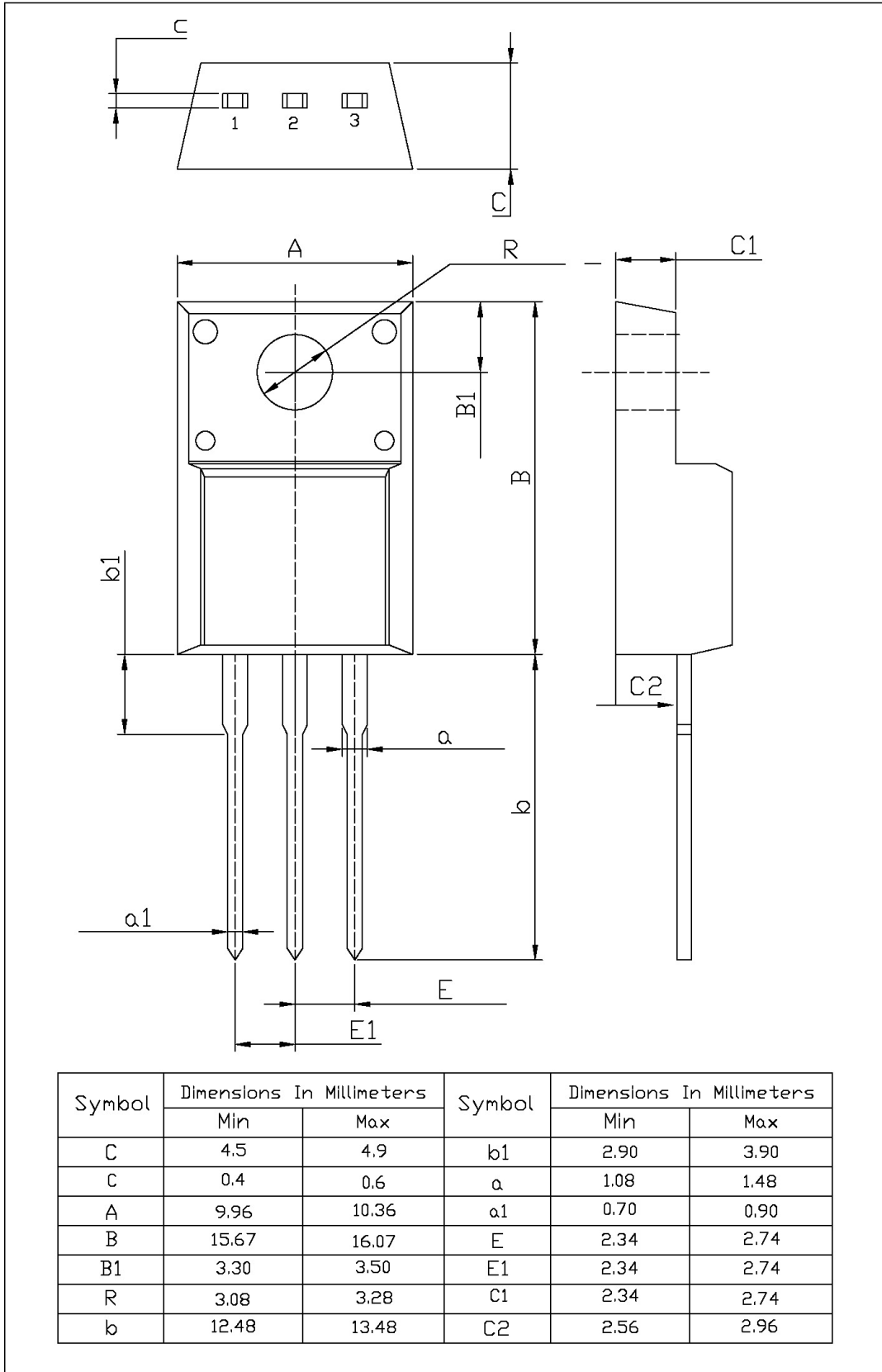

印章说明 / Marking Instructions

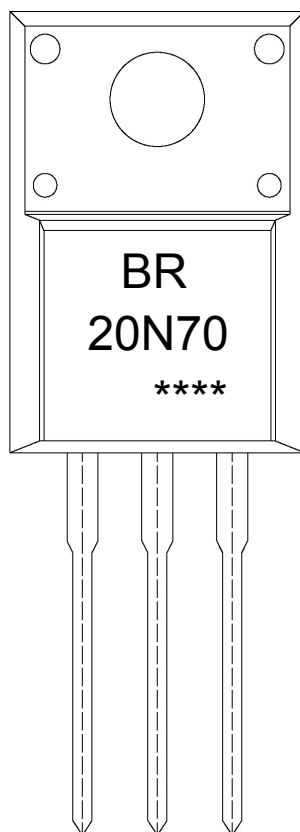

说明：

BR： 为公司代码

20N70： 为型号代码

****： 为生产批号代码，随生产批号变化

Note:

BR: Company Code

20N70: Product Type Code

****: Lot No. Code, code change with Lot No

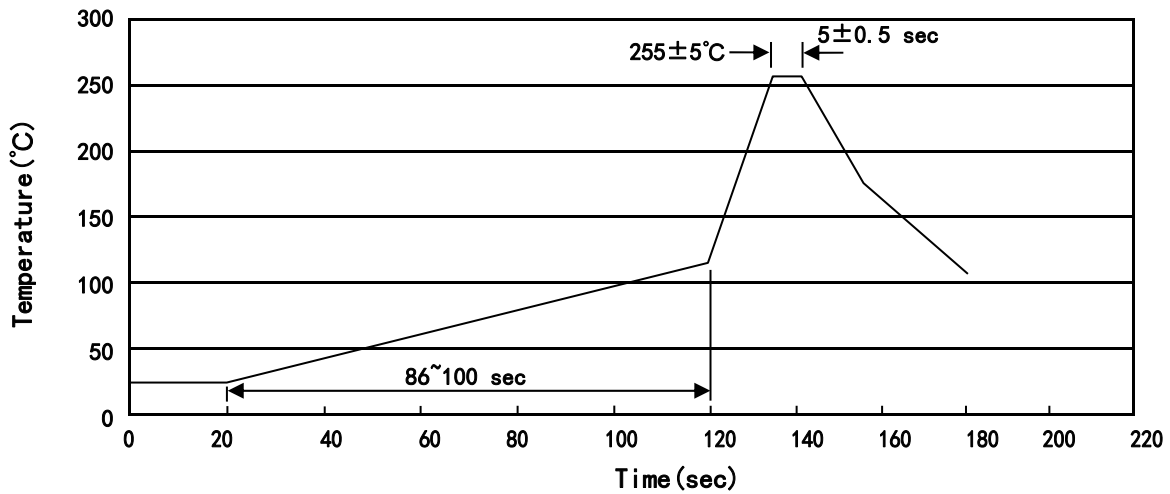
波峰焊温度曲线图(无铅) / Temperature Profile for Dip Soldering(Pb-Free)

说明：

- 1、预热温度 25~150°C，时间 60~90sec;
- 2、峰值温度 255±5°C，时间持续为 5±0.5sec;
- 3、焊接制程冷却速度为 2~10°C/sec.

Note:

- 1.Preheating:25~150°C, Time:60~90sec.
- 2.Peak Temp.:255±5°C, Duration:5±0.5sec.
3. Cooling Speed: 2~10°C/sec.

耐焊接热试验条件 / Resistance to Soldering Heat Test Conditions

温度：270±5°C

时间：10±1 sec.

Temp.:270±5°C

Time:10±1 sec

包装规格 / Packaging SPEC.

套管包装 / TUBE

Package Type 封装形式	Units 包装数量					Dimension 包装尺寸 (unit: mm ³)		
	Units/Tube 只/套管	Tubes/Inner Box 套管/盒	Units/Inner Box 只/盒	Inner Boxes/Outer Box 盒/箱	Units/Outer Box 只/箱	Tube 套管	Inner Box 盒	Outer Box 箱
TO-220FL	50	20	1,000	5	5,000	532×33×7.0	555×164×50	575×290×180

使用说明 / Notices