

BR2SD1815Q

Rev.A Apr.-2022

描述 / Descriptions

TO-252 塑封封装 NPN 半导体三极管。
Silicon NPN transistor in a TO-252 Plastic Package.

特征 / Features

符合 AEC-Q101 标准高可靠性要求，无卤产品。
Qualified to AEC-Q101 Standards for High Reliability, HF Product.

用途 / Applications

继电器驱动器、高速逆变器、转换器和其他一般大电流开关应用，满足汽车应用的严格要求。
Relay drivers, high-speed inverters, converters, and other general high-current switching applications,
Meet the stringent requirements of automotive applications.

内部等效电路 / Equivalent Circuit

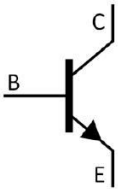

引脚排列 / Pinning

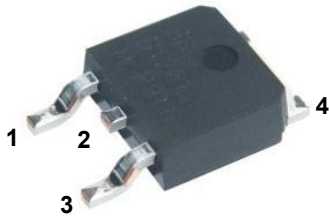

PIN1 : Base PIN 2,4 : Collector PIN 3 : Emitter

放大及印章代码 / h_{FE} Classifications & Marking

h_{FE} Classifications Symbol	Q	R	S	T
h_{FE} Range	70-140	100-200	140-280	200-400

极限参数 / Absolute Maximum Ratings(Ta=25°C)

参数 Parameter	符号 Symbol	数值 Rating	单位 Unit
Collector to Base Voltage	V_{CBO}	120	V
Collector to Emitter Voltage	V_{CEO}	100	V
Emitter to Base Voltage	V_{EBO}	6	V
Collector Current - Continuous	I_C	3	A
Collector Current – Continuous(Pulse)	I_{CP}	6	A
Collector Power Dissipation	P_C	1	W
Collector Power Dissipation	$P_C(T_c=25^\circ\text{C})$	10	W
Junction Temperature	T_j	150	°C
Storage Temperature Range	T_{stg}	-55~150	°C

电性能参数 / Electrical Characteristics(Ta=25°C)

参数 Parameter	符号 Symbol	测试条件 Test Conditions	最小值 Min	典型值 Typ	最大值 Max	单位 Unit
Collector to Base Breakdown Voltage	V_{CBO}	$I_C=10\mu\text{A}$ $I_E=0$	120			V
Collector to Emitter Breakdown Voltage	V_{CEO}	$I_C=1\text{mA}$ $I_B=0$	100			V
Emitter to Base Breakdown Voltage	V_{EBO}	$I_E=10\mu\text{A}$ $I_C=0$	5.0			V
Collector-Base Cut-Off Current	I_{CBO}	$V_{CB}=100\text{V}$ $I_E=0$			1	μA
Emitter-Base Cut-Off Current	I_{EBO}	$V_{CB}=4\text{V}$ $I_C=0$			1	μA
DC Current Gain	$h_{FE(2)}$	$V_{CE}=5.0\text{V}$ $I_C=500\text{mA}$	70		400	
Collector-Emitter Saturation Voltage	$V_{CE(sat)}$	$I_C=1500\text{mA}$ $I_B=150\text{mA}$			0.4	V
Base-Emitter Voltage Saturation Voltage	$V_{BE(sat)}$	$I_C=1500\text{mA}$ $I_B=150\text{mA}$			1.2	V
Transition Frequency	f_T	$V_{CE}=10\text{V}$ $I_C=500\text{mA}$		180		MHz
Collector output capacitance	C_{ob}	$V_{CB}=10\text{V}$ $I_E=0$ $f=1.0\text{MHz}$		25		pF
Turn-on Time	t_{on}	$V_{CC}=50\text{V}$, $I_C=1.5\text{A}$, $I_{B1}=-I_{B2}=-150\text{mA}$		100		ns
Storage Time	t_s			900		ns
Fall Time	t_f			50		ns

电参数曲线图 / Electrical Characteristic Curve

Fig. 1 - Static Characteristics

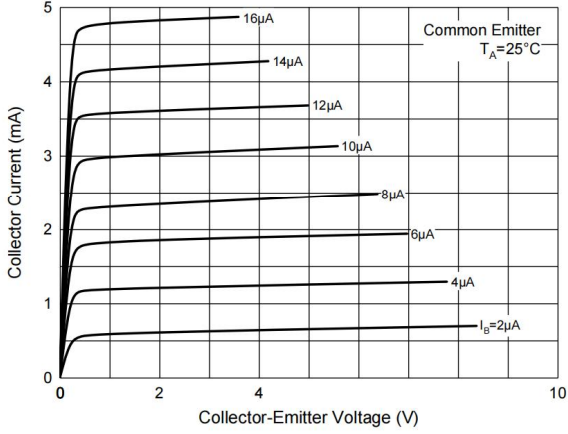

Fig. 2 - DC Current Gain Characteristics

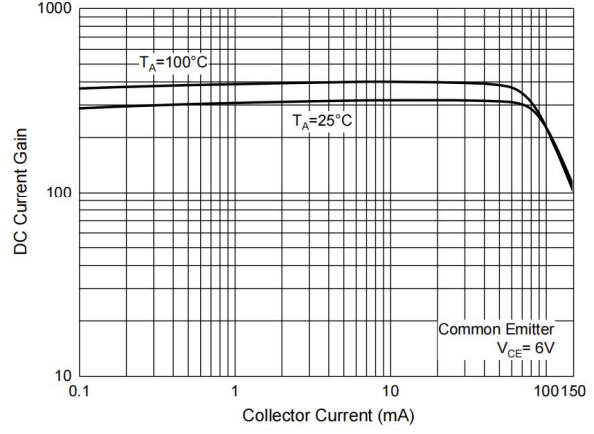

Fig. 3 - Collector-Emitter Saturation Voltage Characteristics

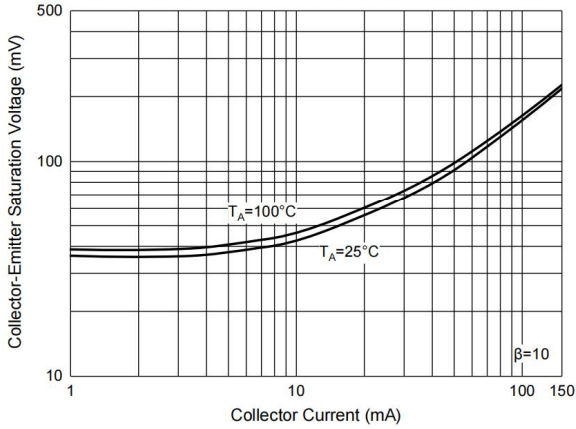

Fig. 4 - Base-Emitter Saturation Voltage Characteristics

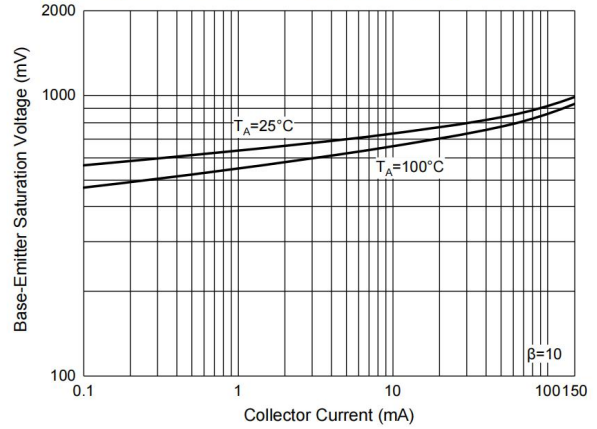

Fig. 5 - Base-Emitter Voltage Characteristics

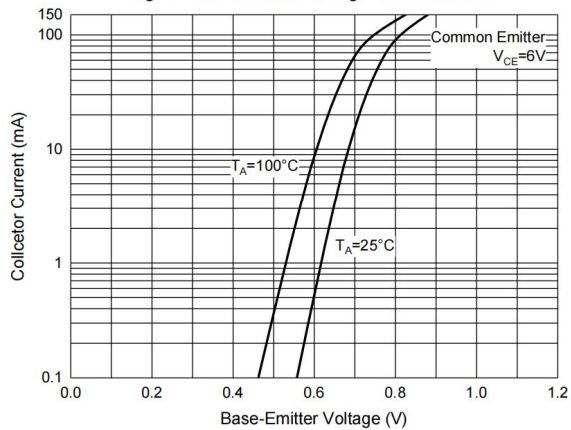
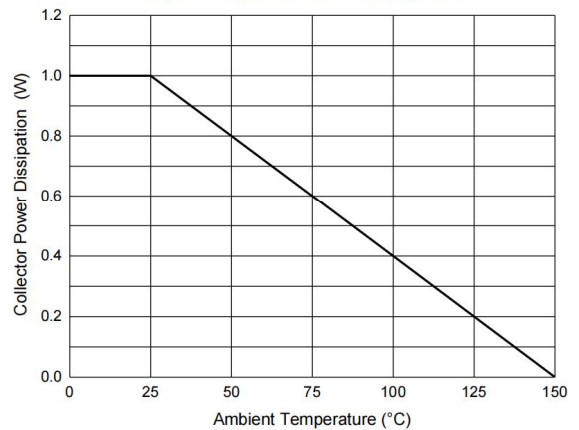
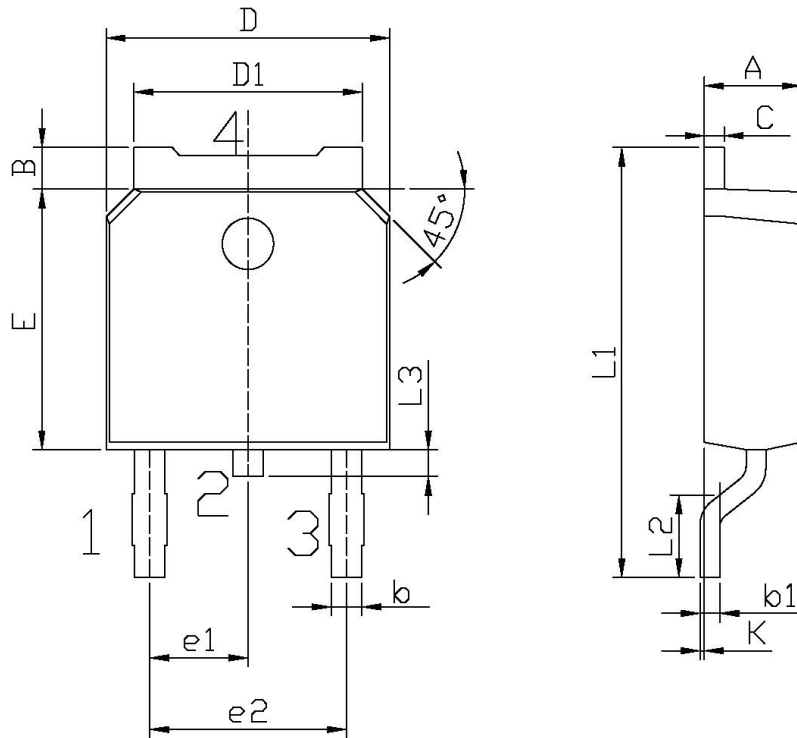

Fig. 6 - Collector Power Derating Curve



外形尺寸图 / Package Dimensions



单位: mm

Symbol	Dimensions In Millimeters		Symbol	Dimensions In Millimeters	
	Min	Max		Min	Max
A	2.20	2.40	E	5.95	6.25
B	0.95	1.25	e1	2.24	2.34
b	0.70	0.90	e2	4.43	4.73
b1	0.45	0.55	L1	9.85	10.35
C	0.45	0.55	L2	1.70	2.00
D	6.45	6.75	L3	0.60	0.90
D1	5.10	5.50	K	0.00	0.10

TO-252

印章说明 / Marking Instructions

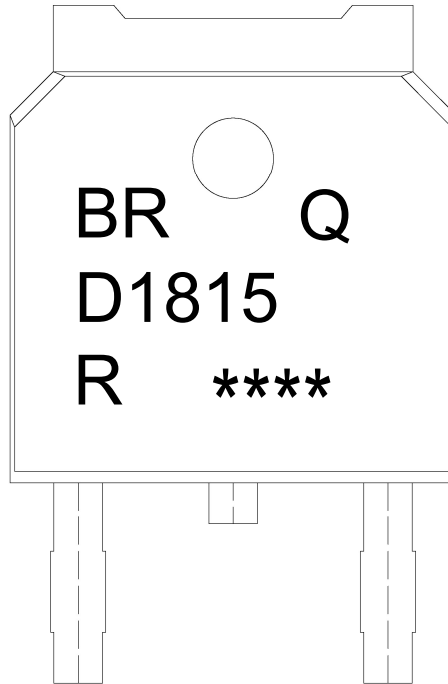

说明：

BR： 为公司代码

Q： 为汽车无卤产品标识

D1815： 为型号代码

R： 为 h_{FE} 分档代码

****： 为生产批号代码，随生产批号变化

Note:

BR: Company Code

Q: Automobile halogen-free product Code

D1815: Product Type.

R: h_{FE} Classifications Symbol

****: Lot No. Code, code change with Lot No

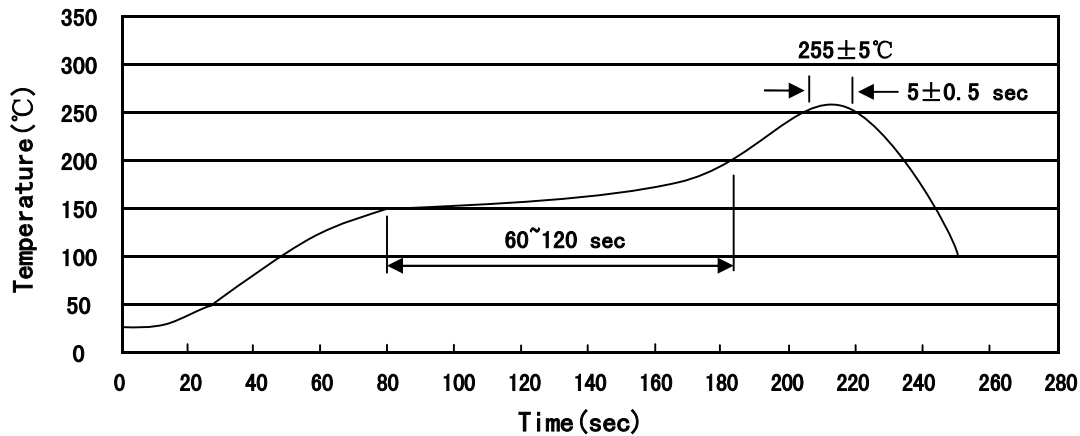
回流焊温度曲线图(无铅) / Temperature Profile for IR Reflow Soldering(Pb-Free)

说明：

- 1、预热温度 150~200°C，时间 60~120sec;
- 2、峰值温度 255±5°C，时间持续为 5±0.5sec;
- 3、焊接制程冷却速度为 2~10°C/sec.

Note:

- 1.Preheating:150~200°C, Time:60~120sec.
- 2.Peak Temp.:255±5°C, Duration:5±0.5sec.
3. Cooling Speed: 2~10°C/sec.

耐焊接热试验条件 / Resistance to Soldering Heat Test Conditions

温度：260±5°C

时间：10±1 sec.

Temp.:260±5°C

Time:10±1 sec

包装规格 / Packaging SPEC.

卷盘包装 / REEL

Package Type 封装形式	Units 包装数量					Dimension 包装尺寸 (unit: mm ³)		
	Units/Reel 只/卷盘	Reels/Inner Box 卷盘/盒	Units/Inner Box 只/盒	Inner Boxes/Outer Box 盒/箱	Units/Outer Box 只/箱	Reel	Inner Box 盒	Outer Box 箱
TO-252	2,500	2	5,000	6	30,000	13" ×16	360×360×50	380×335×366

套管包装 / TUBE

Package Type 封装形式	Units 包装数量					Dimension 包装尺寸 (unit: mm ³)		
	Units/Tube 只/套管	Tubes/Inner Box 套管/盒	Units/Inner Box 只/盒	Inner Boxes/Outer Box 盒/箱	Units/Outer Box 只/箱	Tube 套管	Inner Box 盒	Outer Box 箱
TO-251/252	75	48	3,600	5	18,000	526×20.5×5.25	555×164×50	575×290×180

使用说明 / Notices